

TEKNIC

CE

PHOTOELECTRIC SENSORS



PHOTOELECTRIC SENSORS FT SERIES



WORKING PRINCIPLE

These electronic devices, photoelectric sensors or photocells, use the light emission principle combined with the electronic and are made up of an emitter or luminous source, the light rays of which are detected by a receiver. The variation in luminous signal obtained when interrupting this ray, is converted into an electrical signal and is measured and used by an electrical circuit. The light used is either infrared or red. By making use of this light various type of photo-electric sensors can be made.

The TEKNIC photoelectric sensors are available in direct reflection, with reflector, with polarized light and emitter-receiver versions. Due to their flexibility regarding the various standard programmable versions these products offer the possibility of stock reduction and are easily interchangeable with most of the units available on the market. They are used in the field of automation to check for the presence, counting, position control, etc., and they are compatible with most logic programmers.

TYPE OF SENSING

DIRECT REFLECTION (P TYPE)

In this type of function the emitter of the infrared light and the receiver are close together. The sensing is obtained by the reflection of the rays from the object. In the use of these photocells it is important to bear in mind the colour and the type of surface of the object. With opaque surfaces the sensing distance is affected by the colour of the object, light colours correspond to the maximum distances and vice versa. In the case of shiny objects the effect of the surface is more important than the colour. The sensing distance in the technical data is related to matt white paper.

REFLECTION WITH REFLECTOR (R TYPE)

This type also has the emitter and receiver close together.

The reflection of the light emitted is obtained by using one or more reflectors and the sensing of the object occurs when these rays are interrupted. These photocells allow longer sensing distances as the rays emitted are almost totally reflected towards the receiver.

REFLECTION WITH REFLECTOR – POLARIZED LIGHT (AR TYPE)

Similar to the R type, these photocells use an antireflex device, the use of such a device, which bases its functioning on a polarized band of light, offers considerable advantages and secure readings even when the object to be sensed has a very shiny surface. They are not in the technical data affected by random reflections.

THRU BEAM EMMITER – RECEIVER (B TYPE)

In this type of function the emitter and receiver of infra-red light face each other. Sensing is achieved when this barrier of light is interrupted, they have a high reception as there is no dispersion between emitter and receiver. These photocells are therefore used for large distances where a high security of functioning is required.

M18 types are available with shutters of various diameters to be screwed on to optic part of both photoelectric sensors. This accessory permits detection of small objects in precision detecting applications.

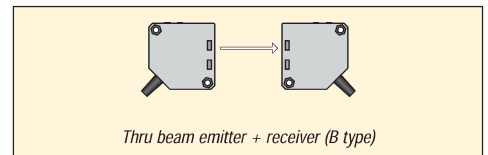
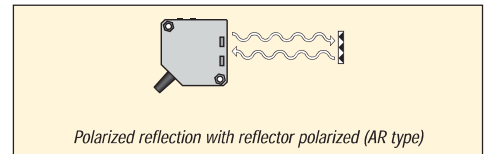
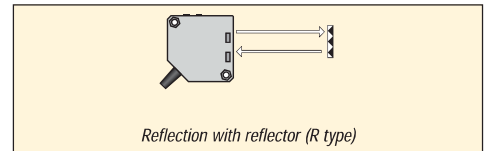
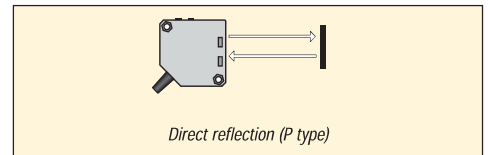

EP 18 M

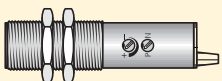

TYPES AVAILABLE

EP 18 M SERIES

Cylindrical construction M18x1, with housing and fixing nuts in nickelled brass. Types available in 10 to 30 VDC, NPN or PNP programmable and NO+NC static output, yellow LED operation indicator, sensitivity adjustment incorporated. All types are available either with axial beam or 90° beam, cable exit or plug for M12 connector.

EP 18 P

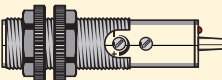

EP 18 P SERIES

Cylindrical construction M18x1 with housing and fixing nuts in plastic material. These are supplied in 10 to 30 VDC with characteristics similar to the FT18SM series and are also available with supply voltage of 20 to 240 VAC with the possibility of programming NO or NC outputs. All models are available with straight or 90 degree angle beam and cable or plug for M12 connector output.

FP 01

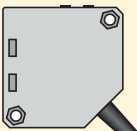

FP 01 SERIES

Compact size in plastic housing, dimensions 50x50x18mm. Types available with supply

voltage of 10 to 30 VDC, NPN or PNP programmable with NO+NC static output. Types available with supply voltage of 12 to 240 VDC/AC (multivoltage) with relay output, programmable by means of a switch for the selection of the relay ON or OFF. All versions are supplied with yellow LED-operation indicator and green LED-stability indicator and trimmer for the sensitivity adjustment. The FP 01 Series is available with cable exit or moving plug for M12 connector to select the direction of the connector exit.

SUGGESTIONS FOR MOUNTING.

- TEKNIC photoelectric sensors are immune to ambient light, attention should however be given to other light sources.
- In disturbed areas or areas that contain materials such as oil, powder etc., it is recommended that the barrier type separating emitter and receiver is used.
- In the use of photocells with standard reflector ensure that they are not too close together, abnormal functioning could result.
- Ensure the photocell is mechanically well fixed in order to avoid movement of the beam due to vibration.
- Attention should be given to the fixing of the connection wires keeping them separated from cables supplying motors, contactors, etc.

PHOTOELECTRIC SENSORS - GENERAL DETAILS

DESCRIPTION OF TECHNICAL TERMINOLOGY

SENSING DISTANCE (Sn)

It is the space in which it is possible to sense an object. In the case of direct reflection types it is the maximum distance between the photocell and the object, in the case of reflector or barrier types it is the distance between unit and the reflector or between units. (see drawing)

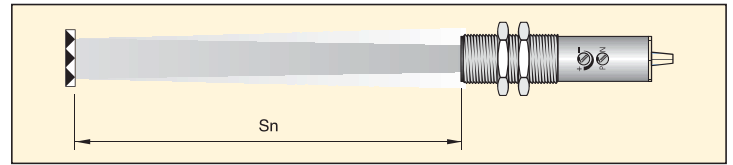

LIGHT ON / DARK ON TYPES OF OUTPUT

For the TEKNIC photocell the same terminology as inductive sensors is used:

N.O. = normally open,

N.C. = normally closed.

This refers to the state of the unit in the absence of product to be sensed.

In the case of photocells light on / dark on is used. In the case of the direct reflection types N.O. is light on and N.C. is dark on. For the other types, N.O. is dark on and N.C. is light on.

TYPE OF LIGHT EMITTED

In photocells the light signal is directed via an optical system to the object to be sensed. All the light emitted by TEKNIC photocells is solid state and can be red or infrared. It is easily modulated and has an unlimited life.

POWER ON DELAY

This is the time lapse between providing a power supply and the activation of the output and is to avoid unwanted switching when the unit is powered.

SWITCHING FREQUENCY

The maximum ON / OFF frequency that the photocell can carry out per second. The maximum values of every unit can be found in the technical characteristics.

NOMINAL VOLTAGE (Vn)

Indicates the maximum and minimum voltage values within which the photocell works correctly.

RESIDUAL RIPPLE

This is the relationship as a percentage between the alternating voltage (peak to peak) superimposed on the continuous supply voltage.

MAX OUTPUT CURRENT

This is the max output current of the photoelectric sensor in continuous function.

ABSORPTION

This is the max current consumption of the photocell referred to the maximum limit of the nominal voltage and without load.

VOLTAGE DROP

This is the voltage drop measured with the photocell when output activates.

SHORT CIRCUIT PROTECTION

All direct current photocells have an incorporated protection which protects the internal circuits from damage in the case of a short circuit on the output stage. Once the short circuit is eliminated the photocell resets.

INTERFERENCE FROM EXTERNAL LIGHT

The table shows the maximum limit of an incandescent light or sunlight. Beyond this limit the photocell may not work correctly due to interference on the receiver.

TEMPERATURE LIMITS

Temperature limits between which the correct functioning of the unit is guaranteed.

IP RATING

This is expressed in IP followed by two numbers. In the case of photocells the first always 6 (completely protected against dust) and the second can be 5 (Protection against water spray) or 7 (protection against full immersion).

CONNECTION IN SERIES AND PARALLEL

CONNECTION OF D.C. TYPES IN SERIES (AND LOGIC)

The photoelectric sensors connected in this way will activate one output when they are excited simultaneously. In this application it is necessary to take into account the following:

- Voltage drop
- Absorption of each photoelectric sensor
- Absorption of the final load.

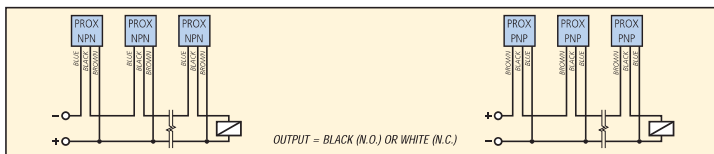
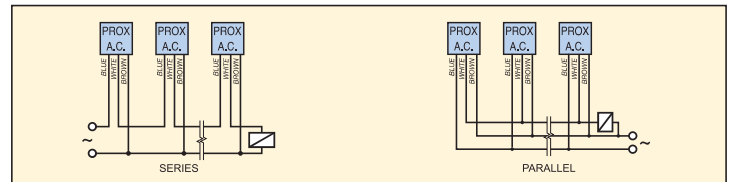

CONNECTION OF D.C. TYPES IN PARALLEL (OR LOGIC)

Connected in this way all photoelectric sensors can activate their common output independently when actuated. In D.C. types put a decoupling diode as indicated.

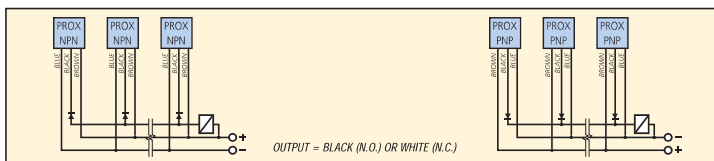

SUGGESTIONS FOR SUPPLYING VOLTAGE TO PHOTOELECTRIC SENSORS (EXAMPLE A-B)

The supply voltage should be adjusted according to the characteristics of the sensor used. It is recommended to use transformer with secondary voltage Vac lower than the direct voltage Vdc required. The secondary voltage Vac is found as follows: $Vac = (Vdc + 1) \cdot 1.41$. The supply voltage Vdc of the sensor should be filtered with a capacitor C of at least 470 μF for each 200 mA used. If the supply voltage Vdc is high it is recommended to follow the diagram B with a proper voltage stabilizer.

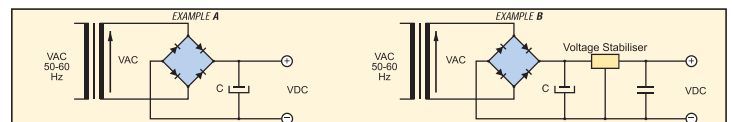

A.C. POWER SUPPLY – SERIES OR PARALLEL CONNECTIONS

Connection can be carried out in series or in parallel.

It is important in the case of parallel connection that the connection is made to the same phase. When connected this way it is important to pay attention to the total current loss (each photocell ≤ 2 mA) which can cause problems in a minimum load.

PHOTOELECTRIC SENSORS EPT 18 M



- METALLIC CYLINDRICAL HOUSING M18x1
- OUTPUT NPN/PNP
- FUNCTIONS NO+NC
- AXIAL BEAM
- ADJUSTABLE SENSITIVITY

TECHNICAL CHARACTERISTICS		
	Dimensions (mm)	
TYPE	DIRECT REFLECTION	
MODEL WITH CABLE	EPTG18M0020UG-2000	EPTG18M0050UG-2000
MODEL WITH PLUG	EPTG18M0020UG-SEM4	EPTG18M0050UG-SEM4
Sensing range (Sn)	cm	* 20 (Adjustable) * 50 (Adjustable)
Programmable output	NPN/PNP NO + NC	
Light source	Led	Infrared
Power on delay	mSec	≤ 100
Switching frequency	Hz	200
Continuous voltage (Res. ripple ≤10%)	V	10 ÷ 30
Max output current	mA	200
Max current consumption at 24 Vdc	mA	≤ 50
Voltage drop (I out=200mA)	V	≤ 1.8
Short circuit protection	Incorporated	
Light immunity	> 10000 Lux	
Led yellow	Operation indicator	
Temperature limits	°C	Storage : -20 ÷ +90 - Working : -20 ÷ +50
Degree of protection	IP	67
Housing	Nickelled brass	
Cable	2m	4 x 0.25 mm ²
Connector plug	M12	

* The sensing distance is related to matt white paper dim. 20 x 20 cm.

<p style="text-align: center;">WIRING DIAGRAMS</p> <p>Note : On request is available cable for sensors with different length: 5 - 10 m.</p>	<p style="text-align: center;">CONNECTION WITH H PLUG</p> <p style="text-align: center;">VIEW OF MALE CONNECTOR</p> <p style="text-align: center;">4 WIRING</p> <p>1 = Brown / + 3 = Blue / - 4 = Black / out NO 2 = White / out NC</p>	<p style="text-align: center;">DETECTION TYPE</p> <p style="text-align: center;">Direct reflection (Type P)</p>
---	---	--

PHOTOELECTRIC SENSORS EPSG 18M / EPEG 18M



- METALLIC CYLINDRICAL HOUSING M18x1
- OUTPUT NPN/PNP
- FUNCTIONS NO+NC
- AXIAL BEAM
- ADJUSTABLE SENSITIVITY

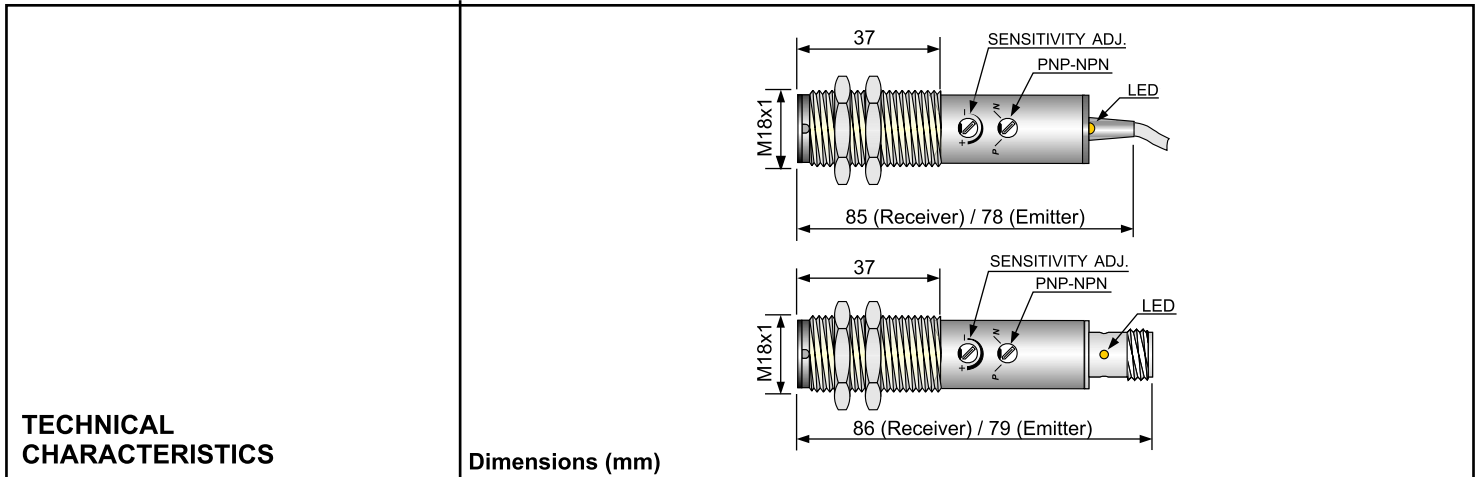

TECHNICAL CHARACTERISTICS		Dimensions (mm)	
TYPE		EMITTER	RECEIVER
MODEL WITH CABLE		EPEG18M1500UG-2000	EPSG18M1500XX-2000
MODEL WITH PLUG		EPEG18M1500UG-SEM4	EPSG18M1500XX-SEM4
Sensing range (Sn)	cm	1500	
Programmable output		NPN/PNP NO + NC	-
Light source	Led	Infrared	
Power on delay	mSec	≤ 100	-
Switching frequency	Hz	200	-
Continuous voltage (Res. ripple ≤10%)	V	10 ÷ 30	
Max output current	mA	200	-
Max current consumption at 24 Vdc	mA	≤ 50	
Voltage drop (I out=200mA)	V	≤ 1.8	-
Short circuit protection		Incorporated	-
Light immunity		> 10000 Lux	
Led		Operation indicator yellow	Power supply green
Temperature limits	°C		
Degree of protection	IP	67	
Housing		Nickelled brass	
Cable	2m	4 x 0.25 mm ²	2 x 0.50 mm ²
Connector plug		M12	

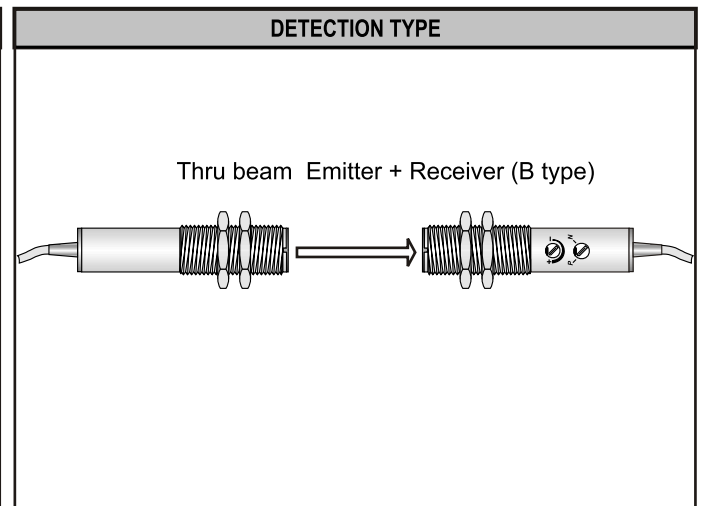
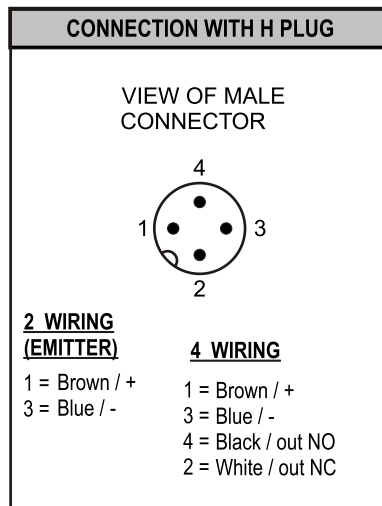
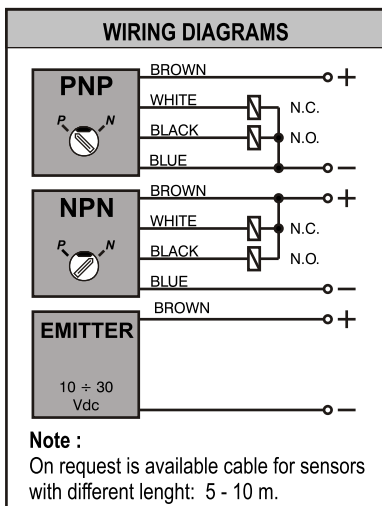

PHOTOELECTRIC SENSORS EPT 18 P



- PLASTIC CYLINDRICAL HOUSING M18X1
- OUTPUT NPN/PNP
- FUNCTIONS NO+NC
- AXIAL BEAM
- ADJUSTABLE SENSITIVITY

TECHNICAL CHARACTERISTICS		
	Dimensions (mm)	
TYPE	DIRECT REFLECTION	
MODEL WITH CABLE	EPTG18P0020UG-2000	EPTG18P0050UG-2000
MODEL WITH PLUG	EPTG18P0020UG-SEM4	EPTG18P0050UG-SEM4
Sensing range (Sn)	cm	* 20 (Adjustable)
Programmable output	NPN/PNP NO + NC	
Light source	Led	Infrared
Power on delay	mSec	≤ 100
Switching frequency	Hz	200
Continuous voltage (Res. ripple ≤10%)	V	10 ÷ 30
Max output current	mA	200
Max current consumption at 24 Vdc	mA	≤ 50
Voltage drop (I out=200mA)	V	≤ 1.8
Short circuit protection	Incorporated	
Light immunity	> 10000 Lux	
Led yellow	Operation indicator	
Temperature limits	°C	Storage : -20 ÷ +90 - Working : -20 ÷ +50
Degree of protection	IP	67
Housing	Plastic	
Cable	2m	4 x 0.25 mm ²
Connector plug	M12	

* The sensing distance is related to matt white paper dim. 20 x 20 cm.

<p>WIRING DIAGRAMS</p> <p>Note : On request is available cable for sensors with different length : 5 - 10 m.</p>	<p>CONNECTION WITH H PLUG</p> <p>VIEW OF MALE CONNECTOR</p> <p>4 WIRING</p> <p>1 = Brown / + 3 = Blue / - 4 = Black / out NO 2 = White / out NC</p>	<p>DETECTION TYPE</p> <p>Direct reflection (Type P)</p>
--	---	--

PHOTOELECTRIC SENSORS EPSG 18P / EPEG 18P



- PLASTIC CYLINDRICAL HOUSING M18x1
- OUTPUT NPN/PNP
- FUNCTIONS NO+NC
- AXIAL BEAM
- ADJUSTABLE SENSITIVITY

TECHNICAL CHARACTERISTICS		Dimensions (mm)	
TYPE		EMITTER	RECEIVER
MODEL WITH CABLE		EPEG18P1500UG-2000	EPSG18P1500XX-2000
MODEL WITH PLUG		EPEG18P1500UG-SEM4	EPSG18P1500XX-SEM4
Sensing range (Sn)	cm	1500	
Programmable output		NPN/PNP NO + NC	-
Light source	Led	Infrared	
Power on delay	mSec	≤ 100	-
Switching frequency	Hz	200	-
Continuous voltage (Res. ripple ≤10%)	V	10 ÷ 30	
Max output current	mA	200	-
Max current consumption at 24 Vdc	mA	≤ 50	
Voltage drop (I out=200mA)	V	≤ 1.8	-
Short circuit protection		Incorporated	-
Light immunity		> 10000 Lux	
Led		Operation indicator yellow	Power supply green
Temperature limits	°C		
Degree of protection	IP	67	
Housing		Nickelled brass	
Cable	2m	4 x 0.25 mm ²	2 x 0.50 mm ²
Connector plug		M12	

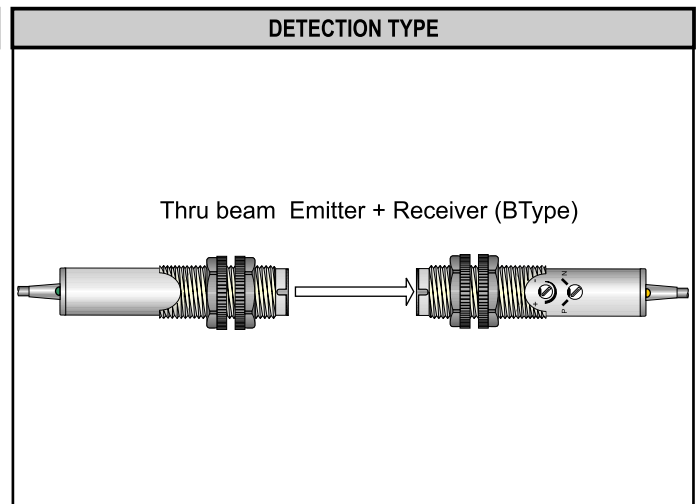
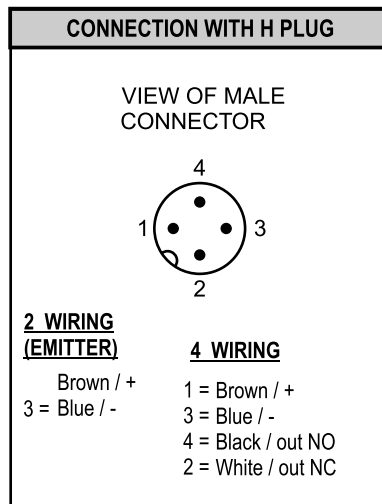
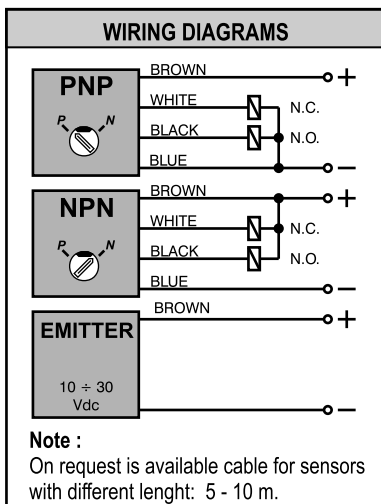
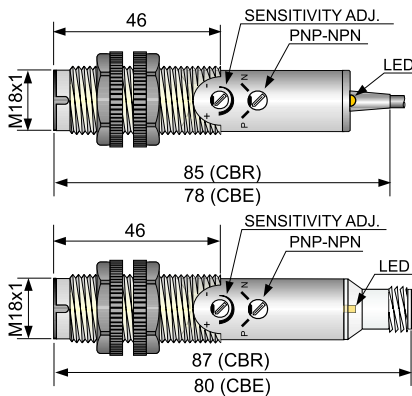

PHOTOELECTRIC SENSORS FPT 01 P



- PLASTIC HOUSING 50 x 50 x 18 mm
- OUTPUT NPN/PNP
- FUNCTIONS NO+NC
- AXIAL BEAM
- ADJUSTABLE SENSITIVITY

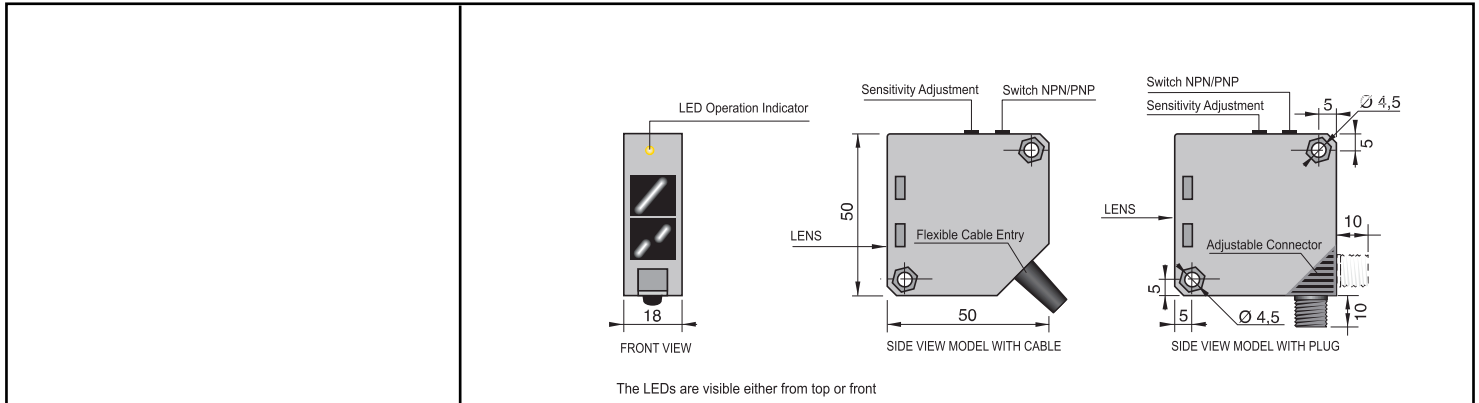

TECHNICAL CHARACTERISTICS

Dimensions (mm)

TYPE	DIRECT REFLECTION	REFLECTION WITH REFLECTOR
MODEL WITH CABLE	FPTG01P0080UG-2000	FPTG01P0500UG-2000
MODEL WITH PLUG	FPTG01P0080UG-SEM4	FPTG01P0500UG-SEM4
Sensing range (Sn)	cm * 80 (Adjustable)	** 500 (Adjustable)
Programmable output	NPN/PNP NO + NC	
Light source	Led	
Power on delay	mSec ≤ 100	
Switching frequency	Hz 200	
Continuous voltage (Res. ripple ≤10%)	V 10 ÷ 30	
Max output current	mA 200	
Max current consumption at 24 Vdc	mA ≤ 50	
Voltage drop (I out=200mA)	V ≤3.0	
Short circuit protection	Incorporated	
Light immunity	> 10000 Lux	
Led yellow	Operation indicator	
Temperature limits	°C Storage : -20 ÷ +90 - Working : -20 ÷ +50	
Degree of protection	IP 67	
Housing	Grey ABS	
Cable	2m 4 x 0.25 mm ²	
Connector plug	M12	

* The sensing distance is related to matt white paper dim. 20 x 20 cm.

** The sensing distance is related to CT80 reflector.

WIRING DIAGRAMS	CONNECTION WITH H PLUG	DETECTION TYPE
<p>PNP</p> <p>NPN</p> <p>Note : On request is available cable for sensors with different length: 5 - 10 m.</p>	<p>VIEW OF MALE CONNECTOR</p> <p>4 WIRING</p> <p>1 = Brown / + 3 = Blue / - 4 = Black / out NO 2 = White / out NC</p>	<p>Direct reflection (Type P)</p> <p>Reflection with reflector (Type R)</p>